

DOME PRESSURE REGULATOR SET 747 LE/S-ES

Complete solution, own-medium controlled



NEW – now also as 747LE/S-ES Smart!

See page 3

**High performance stainless steel dome-loaded pressure regulator set.
For high and varying flows requiring maximum pressure stability.**

Features

- **Pilot Control Tube (PCT)**
One of the features enabling highly accurate control of outlet pressure
- **Balanced Seat Design (BSD)**
Further enabling control precision, high reliability and low maintenance
- **A complete solution, ready to use**
With integrated pilot pressure regulator, and stainless steel pressure gauges, completely assembled and tested
- **Own-medium controlled**
Enabling autonomous operation (no separate gas supply required)
- **Closed system**
Self-relieving design, but no gas is released to atmosphere
- **Simple to install and operate**
Removable spindle enables simple setting of the required outlet pressure
Can be positioned at any angle/orientation
For indoor and outdoor installation.
- Glycerine-filled manometer, unfilled version for oxygen

Operation / Usage

Ideal for process gas supply where pressure accuracy is required even when inlet pressures and flow rates are varying.

High flow rates and outlet pressure accuracy are achieved, even when the difference between inlet and outlet pressures is small.

Also suitable for various aggressive and toxic gases.

Maintenance

Depending on application, moving wetted parts may need replacement every 1-3 years.

For this we offer our Maintenance Set with original spare parts.

Options

- Lockable spindle cap
- Maintenance Set

Approvals

Company certified according to ISO 9001, ISO 22000 and PED 2014/68/EU Module H

CE-marked according to PED 2014/68/EU

ATEX 2014/34/EU with ignition hazard analysis according to EN 1127-1, DIN EN 13463-1 and ZH1/200

Analyzed for Food Safety per HACCP-Analysis

Fulfills the requirements of EU Regulations (EC) 1935/2004, and (EC) 2023/2006

Fulfills the requirements of German Food and Feed (LFGB) Law, and is suitable for contact with food gases

Designed for Oxygen Service in accordance with EIGA 13/20 and CGA G-4.4: Oxygen Pipeline and Piping Systems

Cleaned for Oxygen Service in accordance with EIGA 33/18 and CGA G-4.1: Cleaning of Equipment for Oxygen Service

Available upon request

Certificates and test reports

Other Dome types

Switchover systems/parallel supply systems

Customer-specific/customized versions

DOME PRESSURE REGULATOR SET 747 LE/S-ES

Complete solution, own-medium controlled



	Model		
	747LE/S-ES		
Max. inlet pressure	CO ₂ 363 PSI	O ₂ 435 PSI	other gases 580 PSI
Outlet pressure	7 - 145 PSI		
	7 - 232 PSI	7 - 435 PSI	7 - 435 PSI
Connections	G 1 female 1" NPT female		
Kv-Value	3.6		
Cv-Value	4.2		
Coefficient as per DIN EN ISO 7291	Coefficient of increase in pressure after closing R = 0.01		
	Coefficient of unevenness I = 0.01		
Temperature range	-22°F to +122°F		
Housing	Stainless steel (1.4404)		
Cartridge	Stainless steel (1.4404)		
Membrane	CR		
O-Ring	NBR		
Spring	Stainless steel (1.4310)		
Pressure gauge	Stainless steel housing DIN EN ISO 5171 for O ₂ , DIN EN 837-1 glycerine-filled for other gases		
Weight approx.	31 lb		

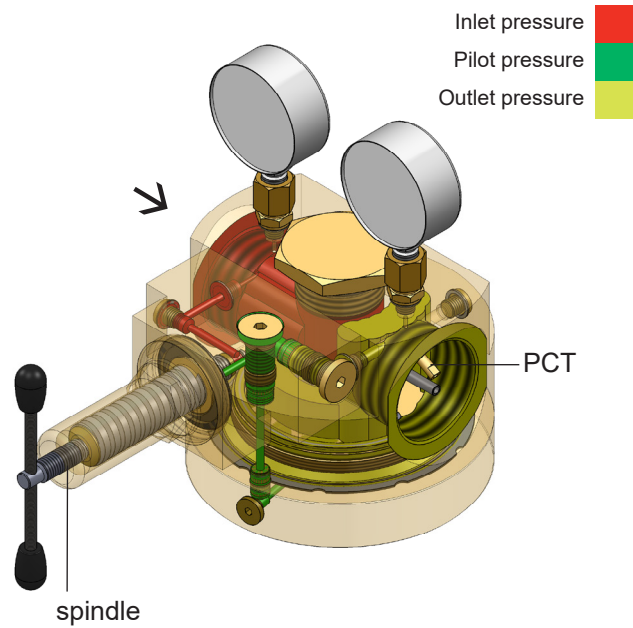

other material/material combinations upon request

Model	Connection G	Dimensions in inches							
		A	B	C	C ₁	H	L	S	AF
747	1" female	7.78	3.11	0.2	-	approx. 8.46	4.74	1.89	-
	1" NPT female	7.78	3.11	0.2	1.22	approx. 8.46	7.19 (L+2xC ₁)	1.89	1.61

other connections upon request

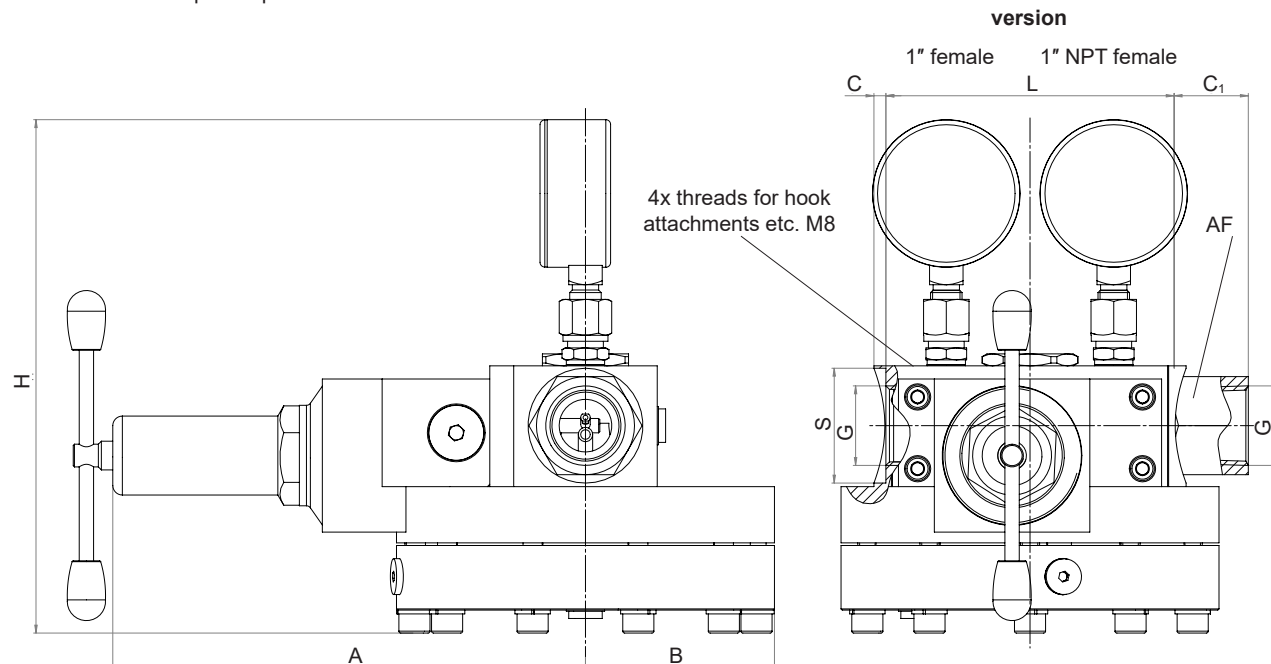

For more pressure regulators visit www.wittgas.us

DOMESTIC PRESSURE REGULATOR SET 747 LE/S-ES SMART



Complete solution, own-medium controlled, including smart features

High performance dome-loaded pressure regulator set for inline installation, combined with high-tech sensor technology and electronic components. The dome pressure regulator 747LE/S-ES Smart can signal, for example, pressures, temperatures and an indication of the flow rate. These signals can be used to optimize performance, safety and maintenance regimes.

WITT dome pressure regulator technology is unique in the world as it offers maximum pressure constancy even at high and fluctuating flow rates or with small differences between inlet and outlet pressure. Now the dome pressure regulator 747LE/S-ES is also available with smart functions: Important operating parameters can be displayed via 4-20 mA signals, enabling the gas supply to be monitored and optimised. Continuous data logging enables quality control and is an important step towards networked production.



Features of WITT dome pressure regulator technology

The extraordinary pressure constancy of WITT dome pressure regulators is the result of a complex technology consisting of perfectly matched components:

- **Pilot Control Tube (PCT)** one of the features enabling highly accurate control of outlet pressure
- **Balanced Seat Design (BSD)** further enabling control precision, high reliability and low maintenance
- A **complete solution**, ready to use with integrated pilot pressure regulator, completely assembled and tested
- **Own-medium controlled** enabling autonomous operation (no separate gas supply required)
- **Closed system** self-relieving design, but no gas is released to atmosphere

Smart Features

In the smart dome pressure regulator, temperature and pressure values are captured by high-tech sensors and transmitted via 4-20 mA signals. Depending on customer requirements, the following features are available individually or combined:

- Signaling and display of inlet pressure (P1) and outlet pressure (P2) in bar and temperature (T1 and T2) in °C
- Signaling and display of the pilot pressure (P3) in bar
- Indication of the instantaneous gas flow rate (FR) in Nm³/h

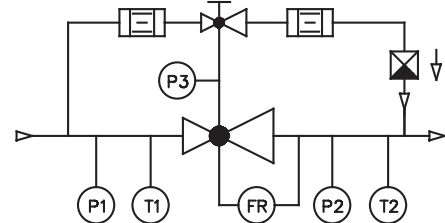

Model variations Smart	Features
"Standard"	Display, indication of inlet pressure and temperature as well as outlet pressure and temperature
"Standard + P3"	"Standard" features, plus indication of pilot pressure
"Standard + Flow"	"Standard" features, plus indication of flow rate
"Standard + P3 + Flow"	"Standard" features, plus indication of pilot pressure and flow rate

Approvals

Company certified according to ISO 9001, ISO 22000 and PED 2014/68/EU Module H

CE-marked according to PED 2014/68/EU

Designed for Oxygen Service in accordance with EIGA 13/20 and CGA G-4.4: Oxygen Pipeline and Piping Systems

Cleaned for Oxygen Service in accordance with EIGA 33/18 and CGA G-4.1: Cleaning of Equipment for Oxygen Service

Optional

Analysed for Food Safety per HACCP-Analysis

Fulfils the requirements of EU Regulations (EC) 1935/2004, and (EC) 2023/2006

Fulfils the requirements of German Food and Feed (LFGB) Law, and is suitable for contact with food gases

DOME PRESSURE REGULATOR SET 747 LE/S-ES SMART



Technical data

	747LE/S-ES Smart		
Max. inlet pressure	CO ₂ 363 PSI	O ₂ 435 PSI	other gases 580 PSI
Outlet pressure	7 - 145 PSI		
	7 - 232 PSI	7 - 435 PSI	7 - 435 PSI
Connections	G 1 female 1" NPT female		
Kv-Value	3.6		
Cv-Value	4.2		
Coefficient as per DIN EN ISO 7291	Coefficient of increase in pressure after closing R = 0.01		
	Coefficient of unevenness I = 0.01		
Temperature range	-22°F to +122°F		
Housing	Stainless steel (1.4404)		
Cartridge	Stainless steel (1.4404)		
Membrane	CR		
O-Ring	NBR		
Spring	Stainless steel (1.4310)		
Application	Non-flammable gases including O ₂ Flammable gases outside Ex Zone		
Power supply	24 V DC		
Protection class	IP 44		
Parameters / Accuracy	Temperature ± 36°F		
	Pressure approx. 1.5% current gas flow - upon request		
Interface	M12, 4-pin plug		
Signals	4 - 20 mA / RS485		
Weight	approx. 31 lb		

other materials / material combinations upon request

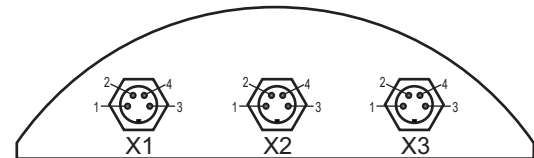
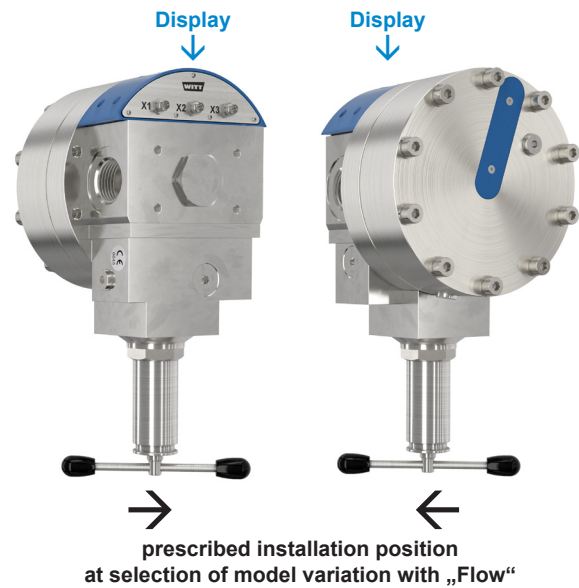

		Connections	
X1	1	P1	Inlet pressure
	2	T1	Temperature inlet
	3	GND	–
	4	P3	Pilot pressure (option)
X2	1	V+	+24 V DC
	2	RS485 A	Transmission of results
	3	GND	–
	4	RS485 B	Transmission of results
X3	1	P2	Outlet pressure
	2	T2	Temperature outlet
	3	GND	–
	4	FR	Flow rate

Model	Connection G	Dimensions in inches							
		A	B	C	C ₁	H	L	S	AF
747	1" female	7.78	3.11	0.04	–	approx. 5.15	4.65	1.89	–
	1" NPT female	7.78	3.11	0.04	1.22	approx. 5.15	7.09 (L+2xC ₁)	1.89	1.61

other connections upon request

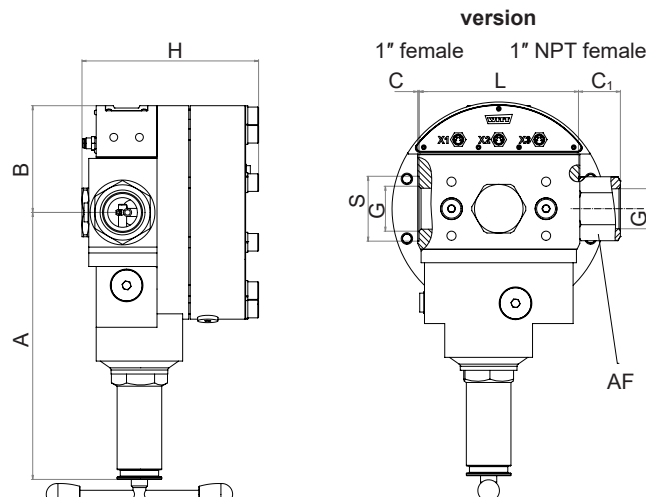

For more pressure regulators visit www.domepressureregulators.com

DOMESTIC PRESSURE REGULATOR SET 747 LE/S-ES

Complete solution, own-medium controlled



Pressure control performance examples (N₂, 68°F : apply conversion factor of x 0.8 for CO₂)

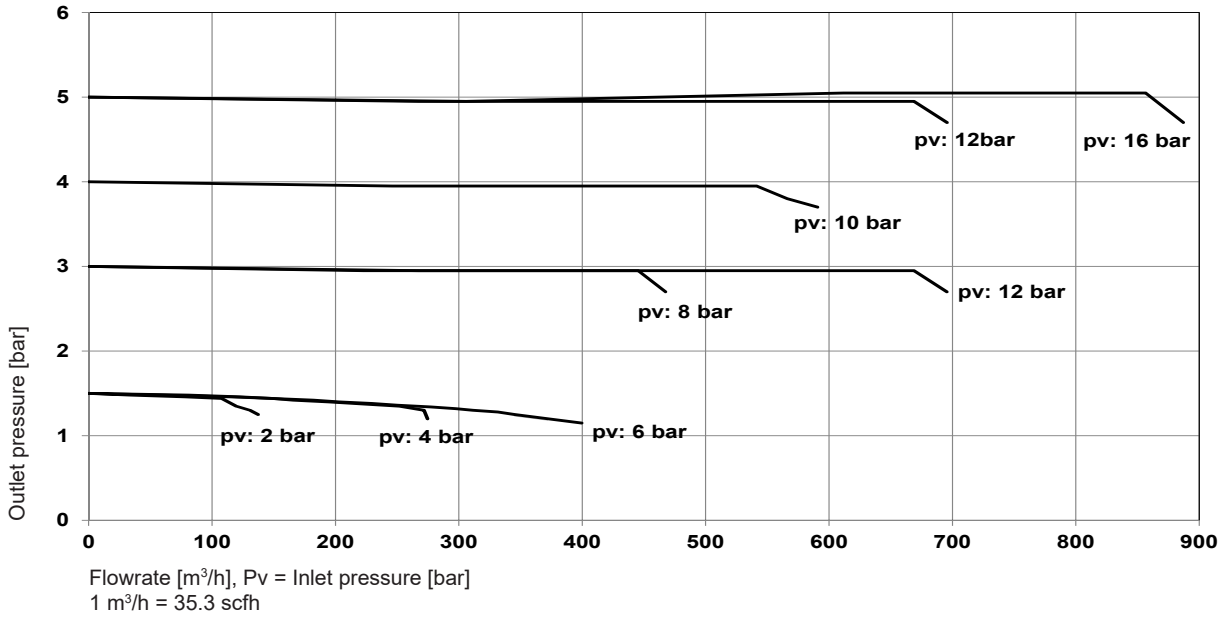

Flow capacity “envelope”

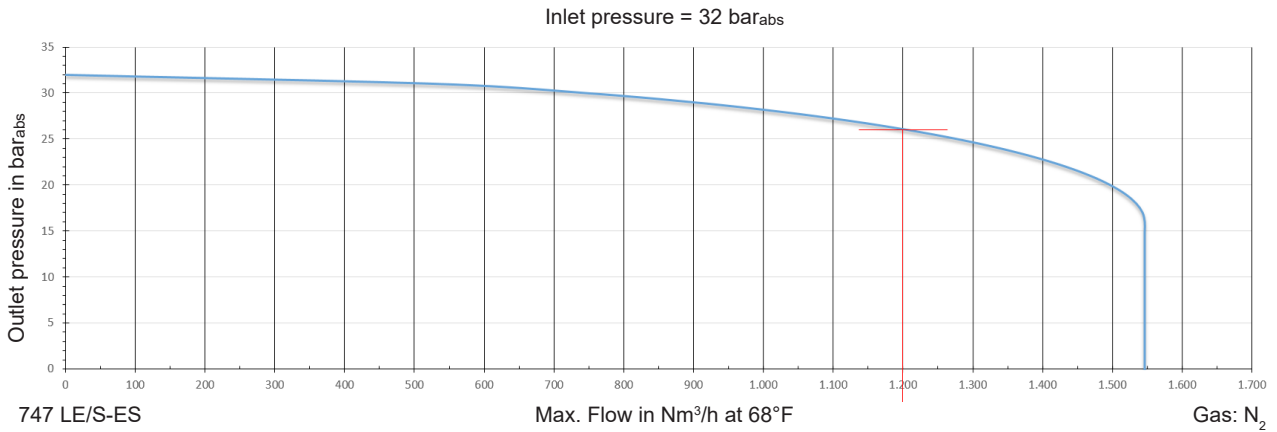

Example:

Inlet pressure: 32 bar_{abs}
 Outlet pressure: 26 bar_{abs}
 Max. Flow: 1 200 Nm³/h
 Gas: N₂

individual graphs with your parameters upon request

DOME PRESSURE REGULATOR SET 747 LE/S-ES

Complete solution, own-medium controlled



Maintenance Set	
Model	Part No.
747LE/S-ES	962.000073

lockable spindle cap	
Model	Part No.
747LE/S-ES	966.061400

