

# DOME PRESSURE REGULATOR SET 757 LE/S

Complete solution, own-medium controlled

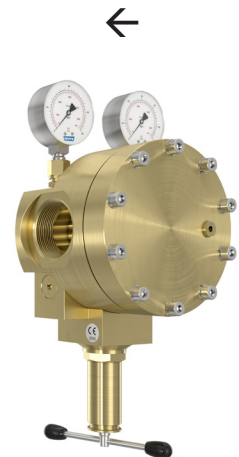
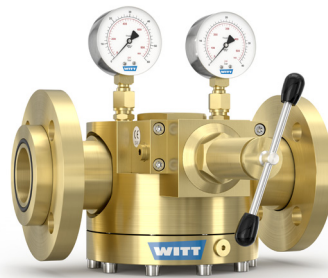

**NEW – now also as 757LE/S Smart!**

See page 3

**High performance dome-loaded pressure regulator set.**

**For high and varying flows requiring maximum pressure stability.**

## Features

- **Pilot Control Tube (PCT)**  
One of the features enabling highly accurate control of outlet pressure
- **Balanced Seat Design (BSD)**  
Further enabling control precision, high reliability and low maintenance
- **A complete solution, ready to use**  
With integrated pilot pressure regulator, and stainless steel pressure gauges, completely assembled and tested
- **Own-medium controlled**  
Enabling autonomous operation (no separate gas supply required)
- **Closed system**  
Self-relieving design, but no gas is released to atmosphere
- **Simple to install and operate**  
Removable spindle enables simple setting of the required outlet pressure  
Can be positioned at any angle / orientation  
For indoor and outdoor installation.
- Glycerine-filled manometer, unfilled version for oxygen

## Operation / Usage

Ideal for process gas supply where pressure accuracy is required even when inlet pressures and flow rates are varying.

High flow rates and outlet pressure accuracy are achieved, even when the difference between inlet and outlet pressures is small.

## Maintenance

Depending on application, moving wetted parts may need replacement every 1-3 years.

For this we offer our Maintenance Set with original spare parts.

## Options

- Lockable spindle cap
- Maintenance Set

## Approvals

Company certified according to ISO 9001, ISO 22000 and PED 2014/68/EU Module H

CE-marked according to PED 2014/68/EU

ATEX 2014/34/EU with ignition hazard analysis according to EN 1127-1, DIN EN 13463-1 and ZH1/200

Analysed for Food Safety per HACCP-Analysis

Fulfils the requirements of EU Regulations (EC) 1935/2004, and (EC) 2023/2006

Fulfils the requirements of German Food and Feed (LFGB) Law, and is suitable for contact with food gases

Designed for Oxygen Service in accordance with EIGA 13/20 and CGA G-4.4: Oxygen Pipeline and Piping Systems

Cleaned for Oxygen Service in accordance with EIGA 33/18 and CGA G-4.1: Cleaning of Equipment for Oxygen Service

## Available upon request

Certificates and test reports

Other Dome types

Switchover systems / parallel supply systems

Customer-specific / customised versions

# DOMESTIC PRESSURE REGULATOR SET 757 LE/S

## Technical data

	Model		
	757LE/S		
<b>Max. inlet pressure</b>	CO <sub>2</sub> 25 bar 363 PSI	O <sub>2</sub> 30 bar 435 PSI	other gases 40 bar 580 PSI
<b>Outlet pressure</b>	0.5 - 10 bar 7 - 145 PSI		
	0.5 - 16 bar 7 - 232 PSI	0.5 - 30 bar 7 - 435 PSI	0.5 - 30 bar 7 - 435 PSI
<b>Connections</b>	Flange DN 50/PN40 DIN EN 1092-1 G 2 female 2" NPT female		
<b>Kv-Value</b>	15		
<b>Cv-Value</b>	17.4		
<b>Coefficient as per DIN EN ISO 7291</b>	Coefficient of increase in pressure after closing R = 0.17		
	Coefficient of unevenness I = 0.01		
<b>Temperature range</b>	-30 °C to +50 °C -22 °F to +122 °F		
<b>Housing</b>	Brass		
<b>Cartridge</b>	Stainless steel (1.4305)		
<b>Membrane</b>	CR		
<b>O-Ring</b>	NBR		
<b>Spring</b>	Stainless steel (1.4310)		
<b>Pressure gauge</b>	Stainless steel housing DIN EN ISO 5171 for O <sub>2</sub> , DIN EN 837-1 glycerine-filled for other gases		
<b>Weight approx.</b>	with flange approx. 26 kg / 57 lb without flange approx. 17 kg / 37 lb		

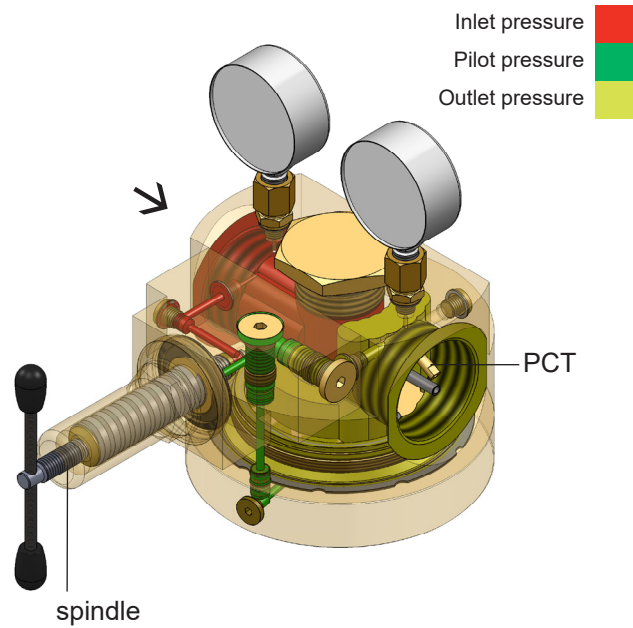

other materials / material combinations upon request

Model	Connection G	Dimensions in mm								
		A	B	C	C <sub>1</sub>	H	L	O (O-ring)	S	SW
757	2" female	197.6	79	8.5	-	approx. 238	141	-	77	-
	2" NPT female	197.6	79	8.5	32	approx. 238	205 (L+2xC <sub>1</sub> )	-	77	70
	DN 50/PN 40	197.6	79	8.5	-	approx. 238	281	64x3	77	65

other connections upon request

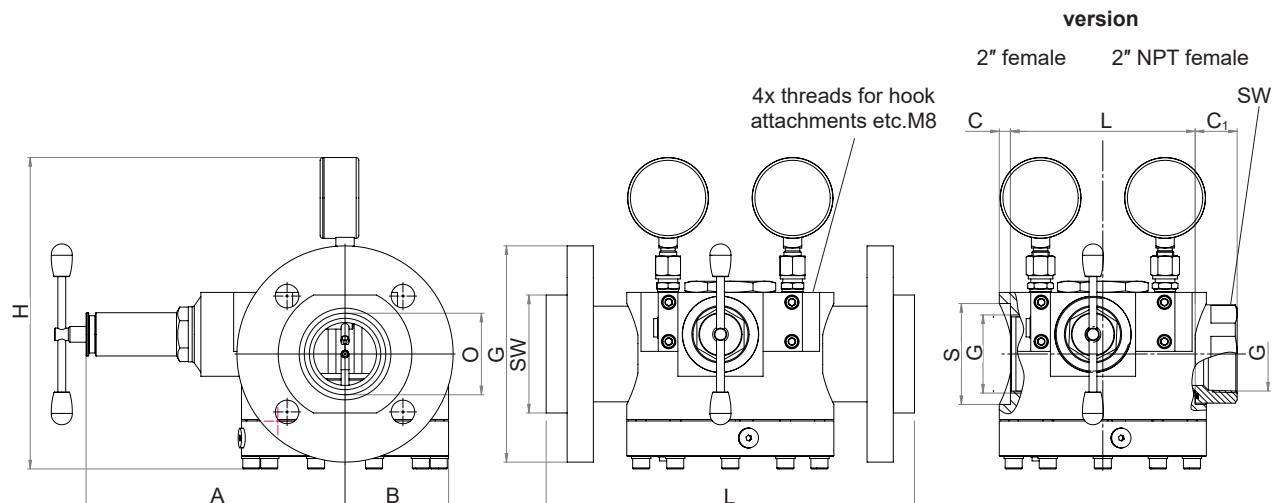

For more pressure regulators visit [www.domepressureregulators.com](http://www.domepressureregulators.com)

# DOMESTIC PRESSURE REGULATOR SET 757 LE/S SMART



## Complete solution, own-medium controlled, including smart features

High performance dome-loaded pressure regulator set for inline installation, combined with high-tech sensor technology and electronic components. The dome pressure regulator 757LE/S Smart can signal, for example, pressures, temperatures and an indication of the flow rate. These signals can be used to optimize performance, safety and maintenance regimes.

WITT dome pressure regulator technology is unique in the world as it offers maximum pressure constancy even at high and fluctuating flow rates or with small differences between inlet and outlet pressure. Now the dome pressure regulator 757LE/S is also available with smart functions: Important operating parameters can be displayed via 4-20 mA signals, enabling the gas supply to be monitored and optimised. Continuous data logging enables quality control and is an important step towards networked production.

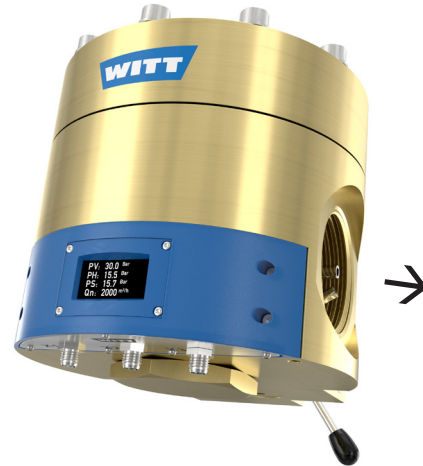

### Features of WITT dome pressure regulator technology

The extraordinary pressure constancy of WITT dome pressure regulators is the result of a complex technology consisting of perfectly matched components:

- **Pilot Control Tube (PCT)** one of the features enabling highly accurate control of outlet pressure
- **Balanced Seat Design (BSD)** further enabling control precision, high reliability and low maintenance
- A **complete solution**, ready to use with integrated pilot pressure regulator, completely assembled and tested
- **Own-medium controlled** enabling autonomous operation (no separate gas supply required)
- **Closed system** self-relieving design, but no gas is released to atmosphere

### Smart Features

In the smart dome pressure regulator, temperature and pressure values are captured by high-tech sensors and transmitted via 4-20 mA signals. Depending on customer requirements, the following features are available individually or combined:

- Signaling and display of inlet pressure (P1) and outlet pressure (P2) in bar and temperature (T1 and T2) in °C
- Signaling and display of the pilot pressure (P3) in bar
- Indication of the instantaneous gas flow rate (FR) in Nm<sup>3</sup>/h

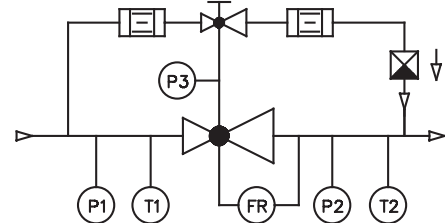

Model variations Smart	Features
"Standard"	Display, indication of inlet pressure and temperature as well as outlet pressure and temperature
"Standard + P3"	"Standard" features, plus indication of pilot pressure
"Standard + Flow"	"Standard" features, plus indication of flow rate
"Standard + P3 + Flow"	"Standard" features, plus indication of pilot pressure and flow rate

### Approvals

Company certified according to ISO 9001, ISO 22000 and PED 2014/68/EU Module H

CE-marked according to PED 2014/68/EU

Designed for Oxygen Service in accordance with EIGA 13/20 and CGA G-4.4: Oxygen Pipeline and Piping Systems

Cleaned for Oxygen Service in accordance with EIGA 33/18 and CGA G-4.1: Cleaning of Equipment for Oxygen Service

### Optional

Analysed for Food Safety per HACCP-Analysis

Fulfils the requirements of EU Regulations (EC) 1935/2004, and (EC) 2023/2006

Fulfils the requirements of German Food and Feed (LFGB) Law, and is suitable for contact with food gases

# DOMESTIC PRESSURE REGULATOR SET 757 LE/S SMART



## Technical data

	757LE/S Smart		
<b>Max. inlet pressure</b>	CO <sub>2</sub> 25 bar 363 PSI	O <sub>2</sub> 30 bar 435 PSI	other gases 40 bar 580 PSI
<b>Outlet pressure</b>	0.5 - 10 bar 7 - 145 PSI		
	0.5 - 16 bar 7 - 232 PSI	0.5 - 30 bar 7 - 435 PSI	0.5 - 30 bar 7 - 435 PSI
<b>Connections</b>	Flange DN 50/PN40 DIN EN 1092-1 G 2 female 2" NPT female		
<b>Kv-Value</b>	15		
<b>Cv-Value</b>	17.4		
<b>Coefficient as per DIN EN ISO 7291</b>	Coefficient of increase in pressure after closing R = 0.17 Coefficient of unevenness I = 0.01		
<b>Temperature range</b>	-30 °C to +50 °C -22 °F to +122 °F		
<b>Housing</b>	Brass		
<b>Cartridge</b>	Stainless steel (1.4305)		
<b>Membrane</b>	CR		
<b>O-Ring</b>	NBR		
<b>Spring</b>	Stainless steel (1.4310)		
<b>Application</b>	Non-flammable gases including O <sub>2</sub> Flammable gases outside Ex Zone		
<b>Power supply</b>	24 V DC		
<b>Protection class</b>	IP 44		
<b>Parameters / Accuracy</b>	Temperature ± 2 °C Pressure approx. 1.5% current gas flow - upon request		
<b>Interface</b>	M12, 4-pin plug		
<b>Signals</b>	4 - 20 mA / RS485		
<b>Weight</b>	with flange approx. 26 kg / 57 lb without flange approx. 17 kg / 37 lb		

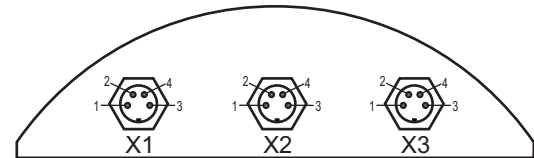
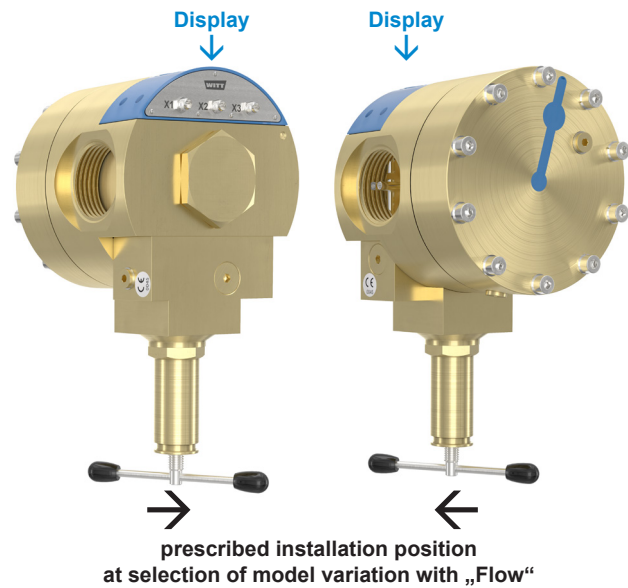

Connections			
X1	1	P1	Inlet pressure
	2	T1	Temperature inlet
	3	GND	–
	4	P3	Pilot pressure (option)
X2	1	V+	+24 V DC
	2	RS485 A	Transmission of results
	3	GND	–
	4	RS485 B	Transmission of results
X3	1	P2	Outlet pressure
	2	T2	Temperature outlet
	3	GND	–
	4	FR	Flow rate

other materials / material combinations upon request

Model	Connection G	Dimensions in mm								
		A	B	C	C <sub>1</sub>	H	L	O (O-ring)	S	SW
757	2" female	198.2	79	8.5	–	approx. 158.5	141	–	77	–
	2" NPT female	198.2	79	8.5	32	approx. 158.5	205 (L+2xC <sub>1</sub> )	–	77	70
	DN 50/PN 40	198.2	79	8.5	–	approx. 158.5	281	64x3	77	90

other connections upon request

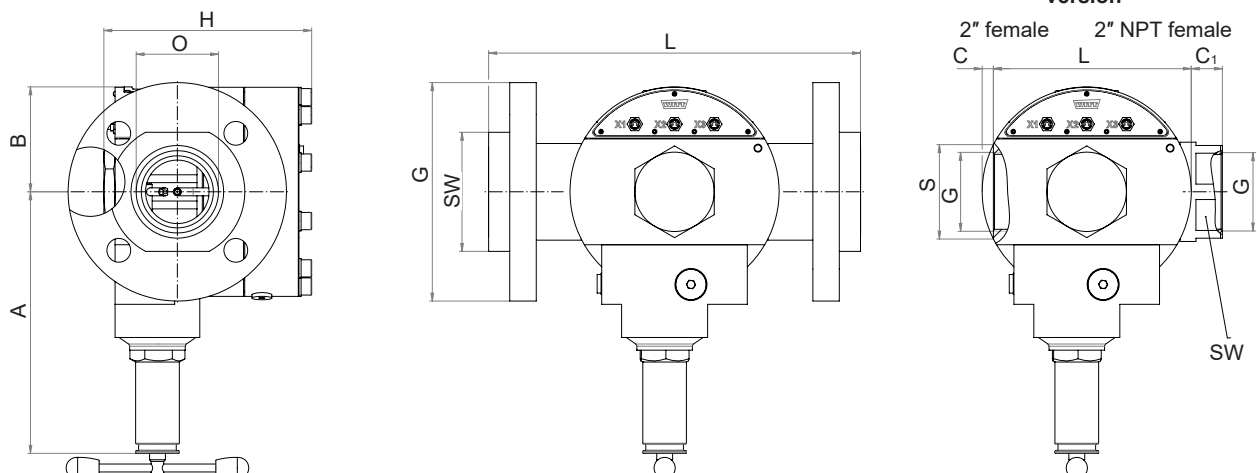

For more pressure regulators visit [www.domepressureregulators.com](http://www.domepressureregulators.com)

# DOME PRESSURE REGULATOR SET 757 LE/S

## Pressure control performance



Pressure control performance examples (N<sub>2</sub>, 20 °C : apply conversion factor of x 0.8 for CO<sub>2</sub>)

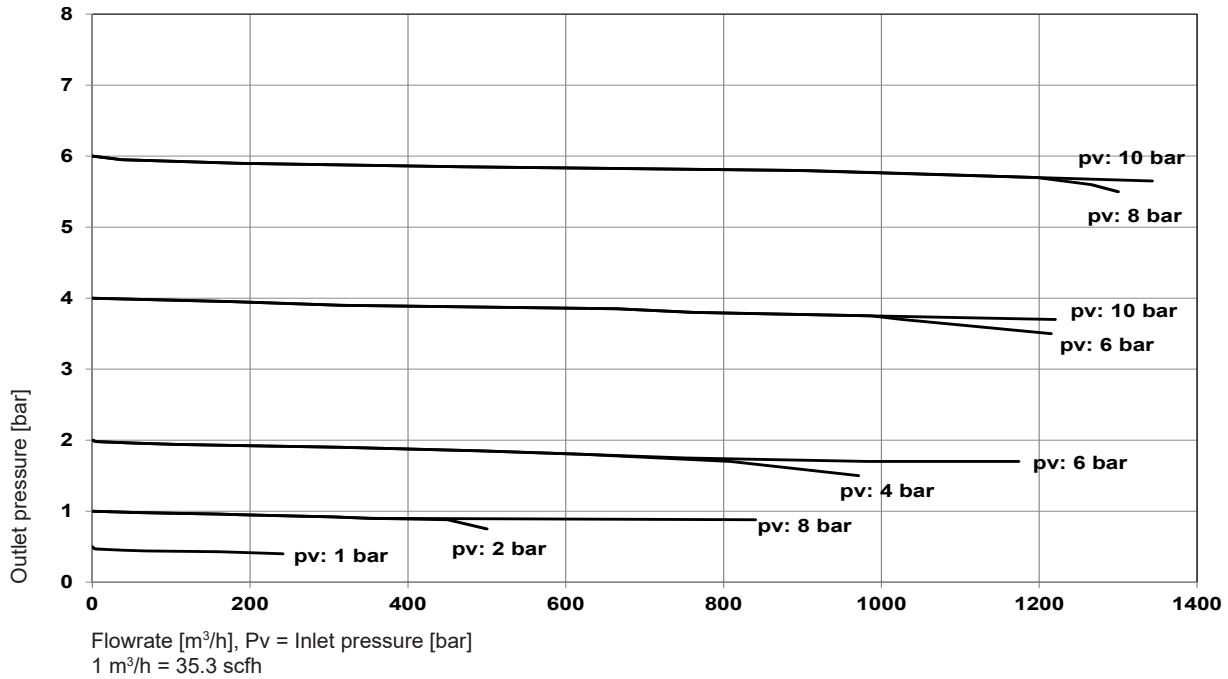

### Flow capacity “envelope”

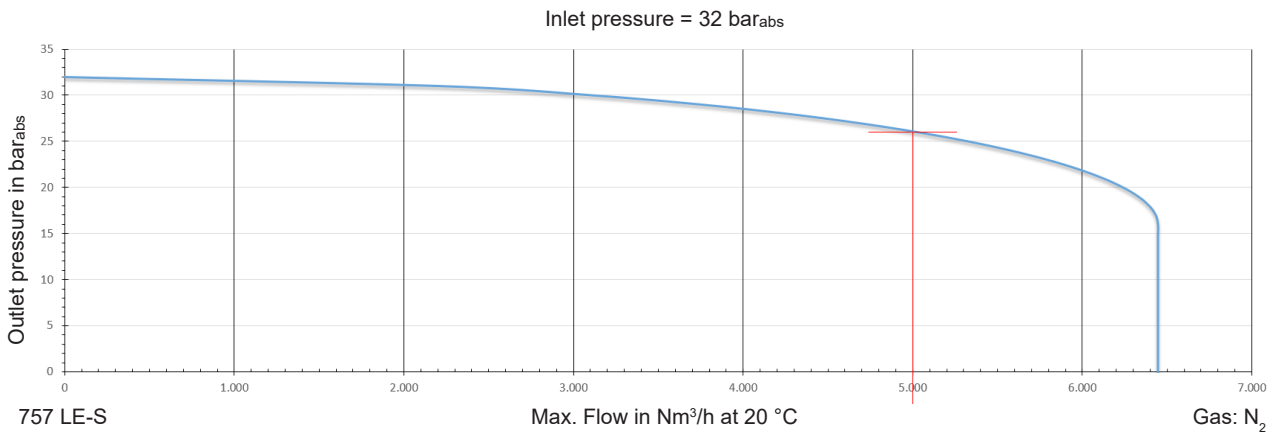

Example:

Inlet pressure: 32 bar<sub>abs</sub>  
 Outlet pressure: 26 bar<sub>abs</sub>  
 Max. Flow: 5,000 Nm<sup>3</sup>/h  
 Gas: N<sub>2</sub>

individual graphs with your parameters upon request

# DOME PRESSURE REGULATOR SET 757 LE/S

## Connections and options

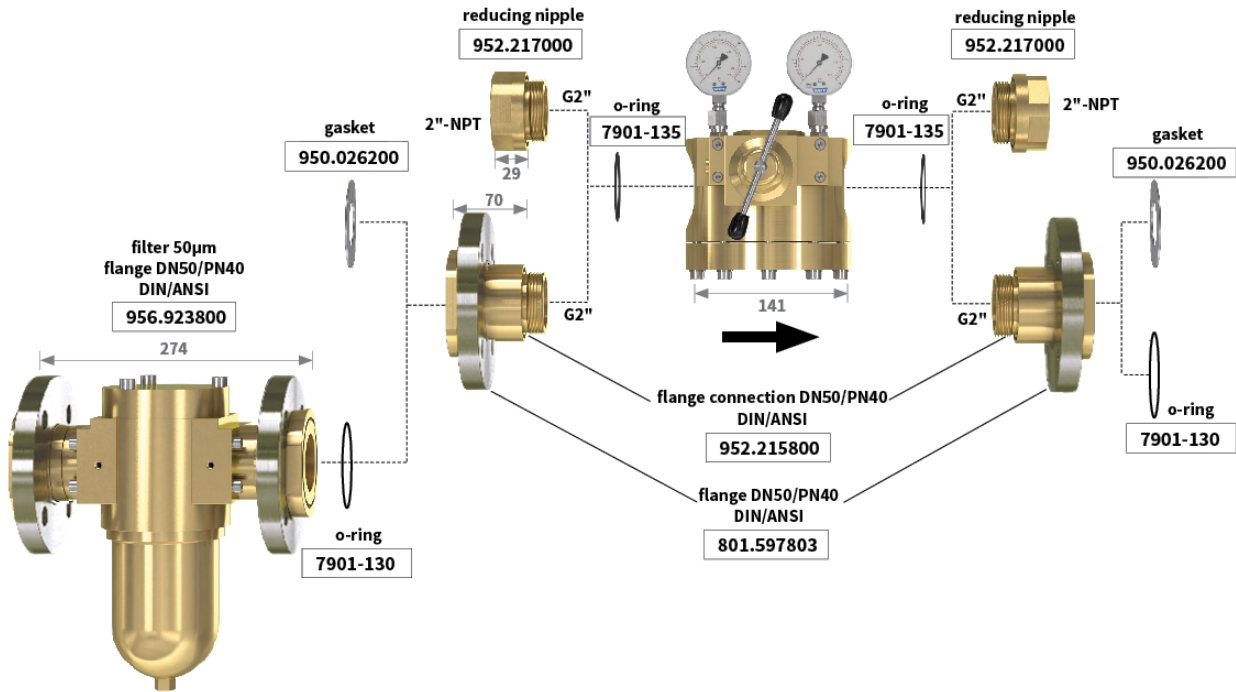

Maintenance Set	
Model	Order-No.
757LE/S	962.000065

Lockable spindle cap	
Model	Order-No.
757LE/S	966.061400

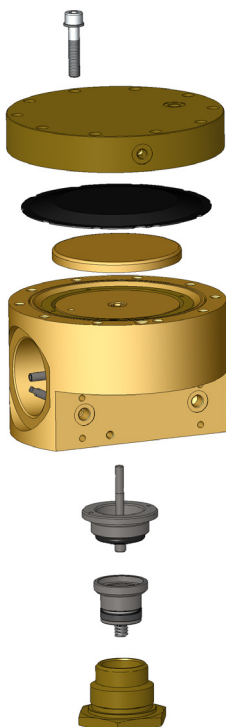

### Maintenance

Depending on application, moving wetted parts may need replacement every 1-3 years.

For this we offer our Maintenance Set with original spare parts.

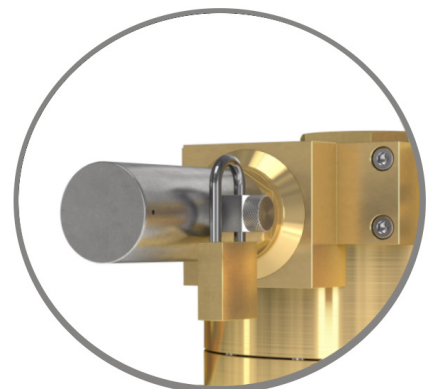

The lockable spindle cap protects the dome pressure regulator from unauthorised or accidental adjustment.